

3 STAKES PER
TREE AT EQUAL
SPACING

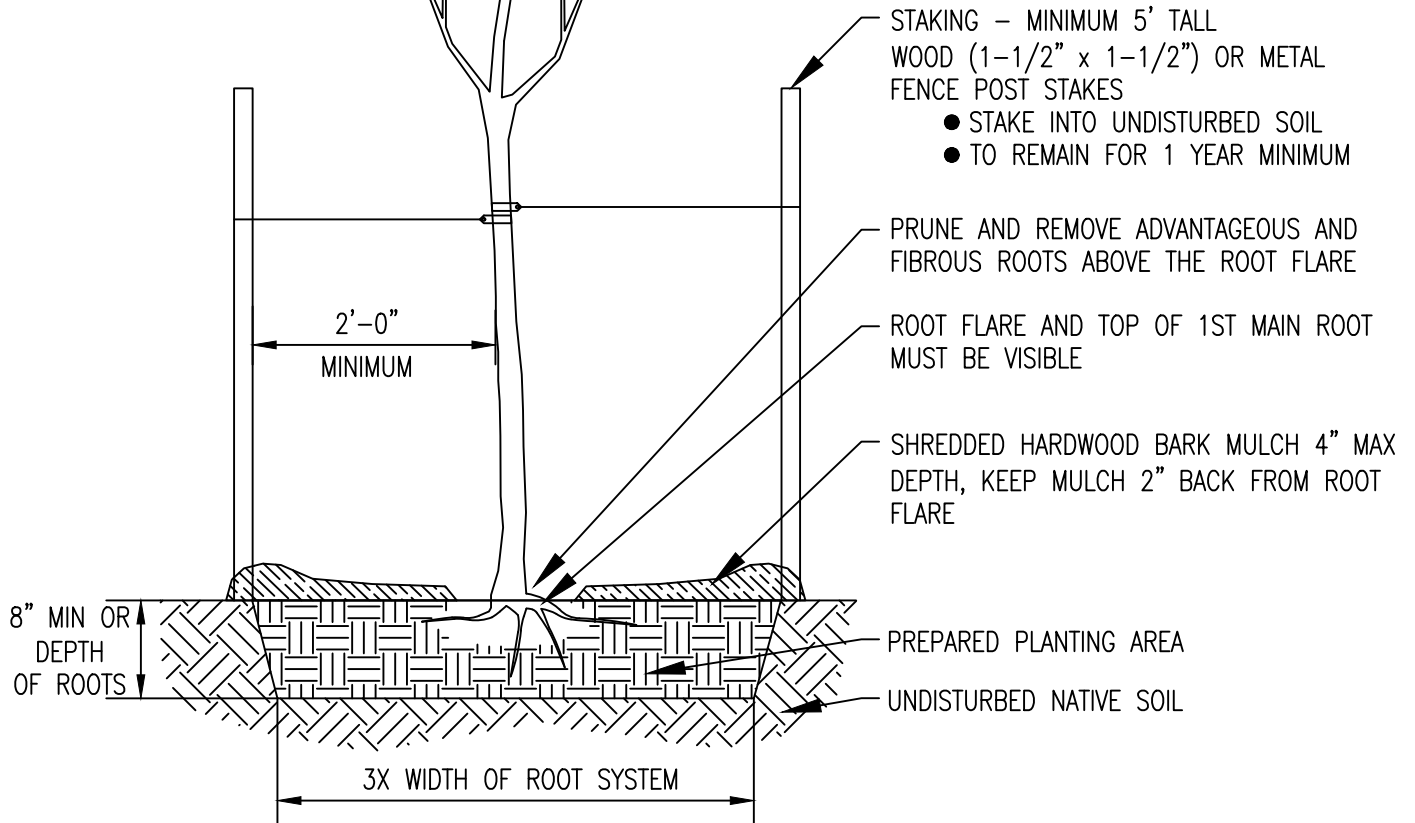

USE OF THIS DETAIL PLATE IS ONLY APPLICABLE IN AREAS OF NON-DISTURBED SOIL LOCATIONS. THE AREA SHOULD NOT BE INCLUDED AS PART OF THE WORK SPACE AND MUST NOT BE COMPACTED OR UTILIZED DURING CONSTRUCTION IN ANY MANNER INCLUDING STAGING OF MATERIALS OR EQUIPMENT. ANY USE OF THIS AREA WOULD THEN REQUIRE REMOVAL AND REPLACEMENT OF SOIL TO CREATE THE REQUIRED 800 CUBIC FEET OF SOIL VOLUME FOR EACH TREE.



BARE-ROOT PREPARATION AND PLANTING
NOT TO SCALE

1. A PLANTING PERMIT IS REQUIRED TO PLANT ANY TREE IN A RIGHT OF WAY IN THE CITY OF ROCHESTER
2. ALL PLANTS MUST MEET THE THE AMERICAN STANDARD FOR NURSERY STOCK (ANSI Z60)
3. IDENTIFY 1ST MAIN ROOT. SET AT GRADE. DIG HOLE ONLY DEEP ENOUGH TO ALLOW FOR UNDISTURBED SOIL DIRECTLY BENEATH TREE ROOTS TO MINIMIZE CHANCE OF SETTLING AND BACKFILL
4. WATER THOROUGHLY TO SETTLE ANY AIR POCKETS AND ADD SOIL IF SINK HOLES DEVELOP
5. ROOT FLARE AND TOP OF 1ST MAIN ROOT MUST BE VISIBLE WHEN BACK FILLING IS COMPLETE
6. EACH TREE REQUIRES A MINIMUM 800 CUBIC FEET OF NON-COMPACTED LOAM SOILS

1. DO NOT ALLOW ROOTS TO DRY OUT
2. DO NOT BRING TREES TO THE SITE UNLESS THEY WILL BE IMMEDIATELY PLANTED
3. KEEP PLANTS MOIST, COOL AND OUT OF DIRECT SUNLIGHT BEFORE PLANTING PREVENT EXPOSURE OF ROOTS TO NO MORE THAN 5 MINUTES

DEPARTMENT OF PUBLIC WORKS CITY OF ROCHESTER, MINNESOTA			
TREE PLANTING DETAIL TYPE 1			
 CITY FORESTER		 PARKS & REC DIRECTOR	
SHT 1 OF 3 SHTS	DATE REVISED 3/23/18	PLATE NO. 5-01	REV. A

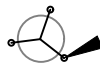

3 STAKES PER TREE AT EQUAL SPACING

USE OF THIS DETAIL PLATE IS ONLY APPLICABLE IN AREAS OF NON-DISTURBED SOIL LOCATIONS. THE AREA SHOULD NOT BE INCLUDED AS PART OF THE WORK SPACE AND MUST NOT BE COMPACTED OR UTILIZED DURING CONSTRUCTION IN ANY MANNER INCLUDING STAGING OF MATERIALS OR EQUIPMENT. ANY USE OF THIS AREA WOULD THEN REQUIRE REMOVAL AND REPLACEMENT OF SOIL TO CREATE THE REQUIRED 800 CUBIC FEET OF SOIL VOLUME FOR EACH TREE.

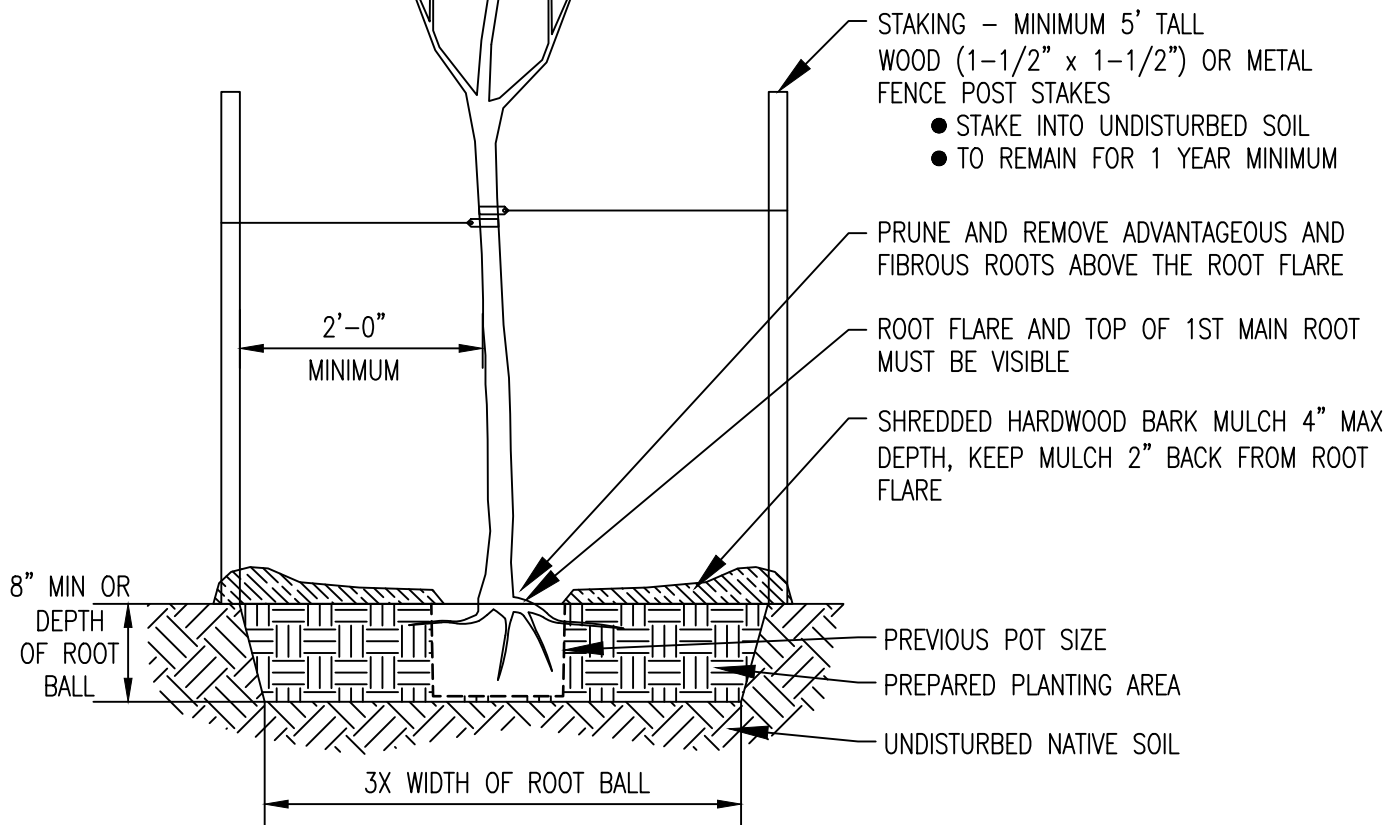



POTTED TREE ROOT BALL PREPARATION AND PLANTING
NOT TO SCALE

1. A PLANTING PERMIT IS REQUIRED TO PLANT ANY TREE IN A RIGHT OF WAY IN THE CITY OF ROCHESTER
2. ALL PLANTS MUST MEET THE "AMERICAN STANDARD FOR NURSERY STOCK" (ANSI Z60)
3. IDENTIFY 1ST MAIN ROOT. SET AT GRADE. DIG HOLE ONLY DEEP ENOUGH TO ALLOW FOR UNDISTURBED SOIL DIRECTLY BENEATH TREE ROOTS TO MINIMIZE CHANCE OF SETTLING AND BACKFILL
4. WATER THOROUGHLY TO SETTLE ANY AIR POCKETS AND ADD SOIL IF SINK HOLES DEVELOP
5. ROOT FLARE AND TOP OF 1ST MAIN ROOT MUST BE VISIBLE WHEN BACK FILLING IS COMPLETE
6. EACH TREE REQUIRES A MINIMUM 800 CUBIC FEET OF NON-COMPACTED LOAM SOILS

1. IDENTIFY 1ST MAIN ROOT AND REMOVE ALL SOIL AND ASSOCIATED ROOT MASS ABOVE IT. "BOX CUT" THE ROOT BALL BY USING A SAW TO CUT 4 FLAT SIDES REMOVING OUTER 1" OF SOIL AND ROOTS. MEASURE THE DEPTH OF THE ROOT BALL AND DIG HOLE TO THIS DEPTH.
2. IF TREES ARE BROUGHT TO THE SITE EARLY ENSURE THAT POTS ARE STORED IN A SHADED AREA AND ADEQUATELY WATERED BEFORE PLANTING

DEPARTMENT OF PUBLIC WORKS
CITY OF ROCHESTER, MINNESOTA

**TREE PLANTING DETAIL
TYPE 2**

 CITY FORESTER	 PARKS & REC DIRECTOR		
SHT 2 OF 3 SHTS	DATE REVISED 3/23/18	PLATE NO. 5-01	REV. A



3 STAKES PER TREE AT EQUAL SPACING

USE OF THIS DETAIL PLATE IS ONLY APPLICABLE IN AREAS OF NON-DISTURBED SOIL LOCATIONS. THE AREA SHOULD NOT BE INCLUDED AS PART OF THE WORK SPACE AND MUST NOT BE COMPACTED OR UTILIZED DURING CONSTRUCTION IN ANY MANNER INCLUDING STAGING OF MATERIALS OR EQUIPMENT. ANY USE OF THIS AREA WOULD THEN REQUIRE REMOVAL AND REPLACEMENT OF SOIL TO CREATE THE REQUIRED 800 CUBIC FEET OF SOIL VOLUME FOR EACH TREE.

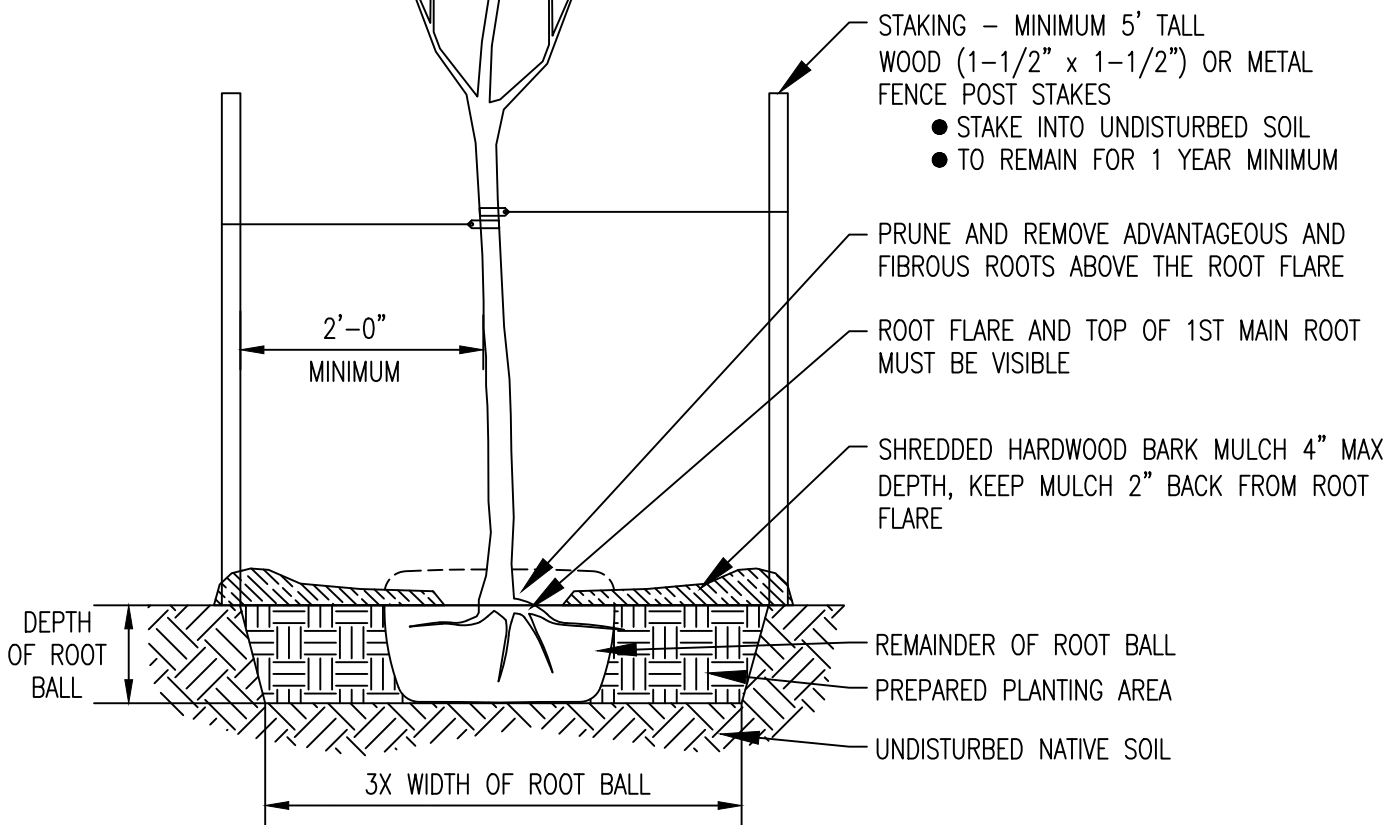



BALL AND BURLAP (B&B) ROOT BALL PREPARATION AND PLANTING
NOT TO SCALE

1. A PLANTING PERMIT IS REQUIRED TO PLANT ANY TREE IN A RIGHT OF WAY IN THE CITY OF ROCHESTER
2. ALL PLANTS MUST MEET THE "AMERICAN STANDARD FOR NURSERY STOCK" (ANSI Z60)
3. IDENTIFY 1ST MAIN ROOT. SET AT GRADE. DIG HOLE ONLY DEEP ENOUGH TO ALLOW FOR UNDISTURBED SOIL DIRECTLY BENEATH TREE ROOTS TO MINIMIZE CHANCE OF SETTLING AND BACKFILL
4. WATER THOROUGHLY TO SETTLE ANY AIR POCKETS AND ADD SOIL IF SINK HOLES DEVELOP
5. ROOT FLARE AND TOP OF 1ST MAIN ROOT MUST BE VISIBLE WHEN BACK FILLING IS COMPLETE
6. EACH TREE REQUIRES A MINIMUM 800 CUBIC FEET OF NON-COMPACTED LOAM SOILS

1. REMOVE TOP $\frac{1}{3}$ OF PACKAGING TO FIND THE 1ST MAIN ROOT AND REMOVE ALL SOIL FROM ROOT BALL ABOVE IT. DIG HOLE TO DEPTH OF REMAINING ROOT BALL DEPTH AND PLACE THE TREE IN THE HOLE. REMOVE ALL REMAINING PACKAGING AND BACKFILL WITHOUT COMPACTING THE SOIL
2. IF TREES ARE BROUGHT TO THE SITE EARLY ENSURE THAT TREES ARE STORED IN A SHADED AREA AND ADEQUATELY WATERED BEFORE PLANTING

DEPARTMENT OF PUBLIC WORKS
CITY OF ROCHESTER, MINNESOTA

**TREE PLANTING DETAIL
TYPE 3**

 CITY FORESTER	 PARKS & REC DIRECTOR		
SHT 3 OF 3 SHTS	DATE REVISED 3/23/18	PLATE NO. 5-01	REV. A

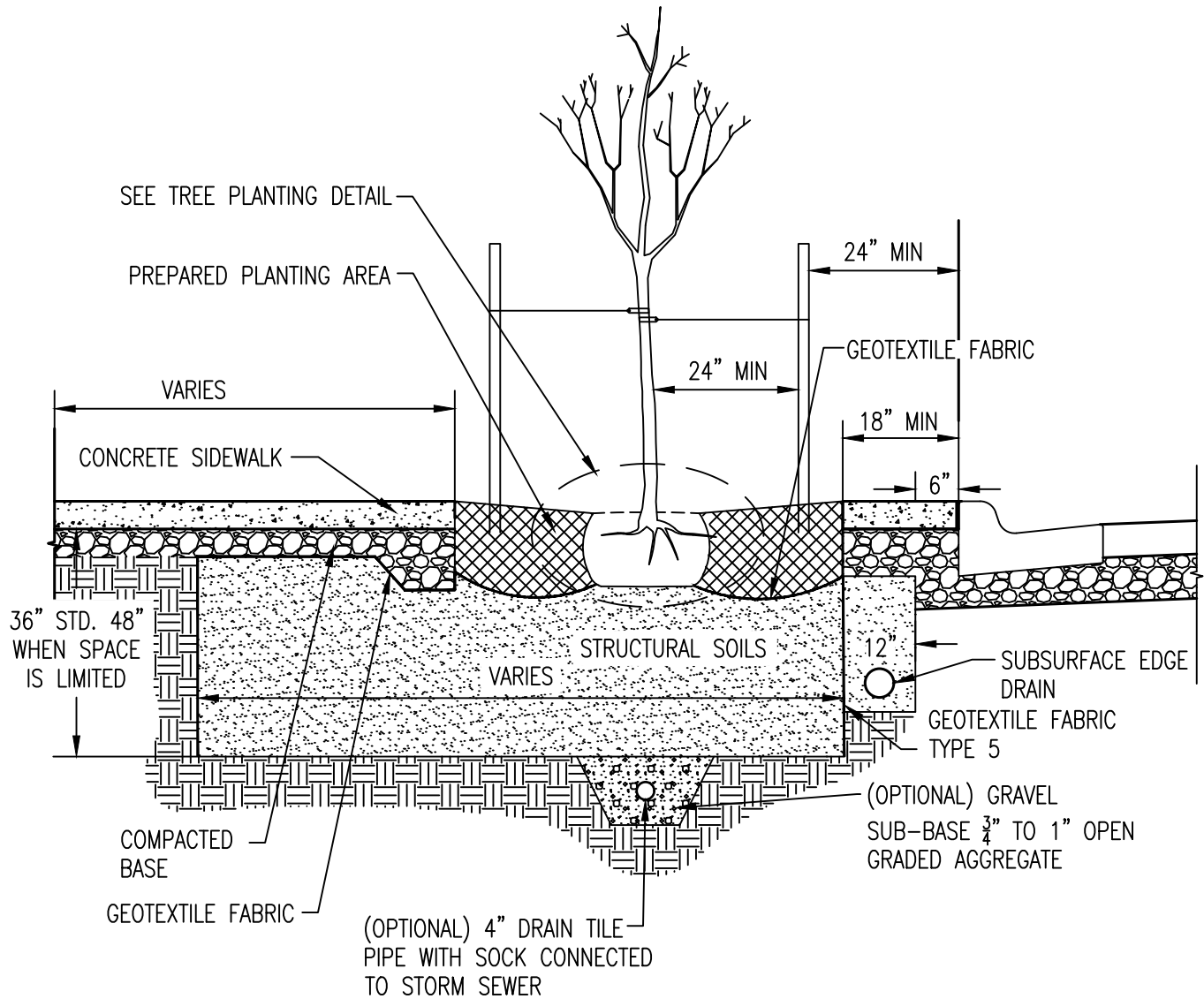
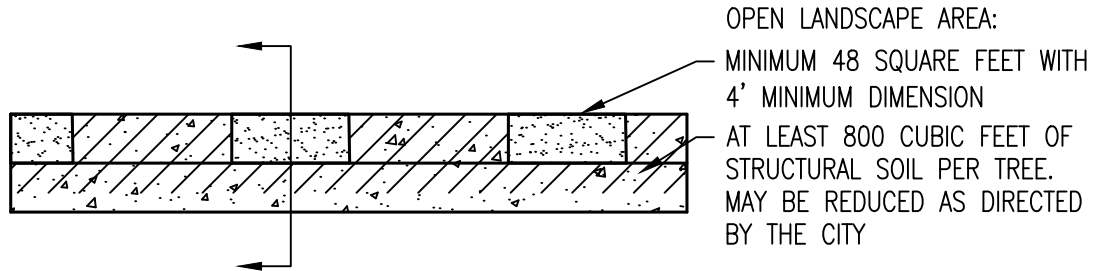



STRUCTURAL SOILS
NOT TO SCALE

1. REQUIRED IN THE CENTRAL BUSINESS DISTRICT
2. SOIL MIXTURE SHALL BE CONSISTENT WITH STRUCTURAL SOILS STANDARDS & SPECIFICATIONS SECTION 1010 OF THE ENGINEERING STANDARDS FOR ROCHESTER, MN
3. DRAIN TILE MAY BE REQUIRED DEPENDING ON SOIL CONDITIONS AS DIRECTED BY THE CITY

ALTERNATIVE: A FIBERGLASS REINFORCED, POLYPROPYLENE CELLULAR SYSTEM MAY BE SUBSTITUTED, AS OTHERWISE APPROVED BY THE ENGINEER

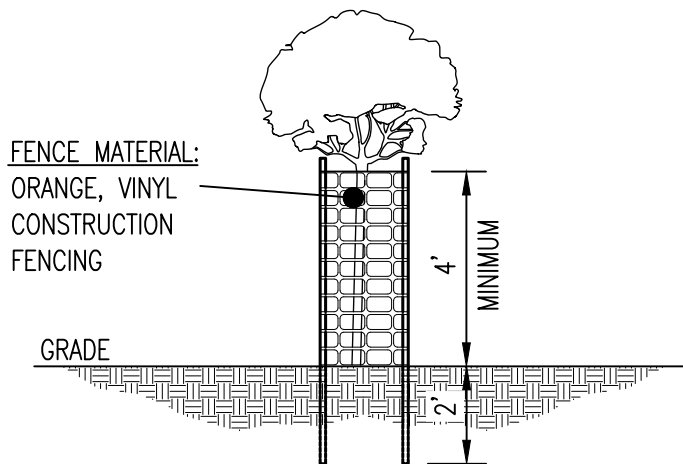
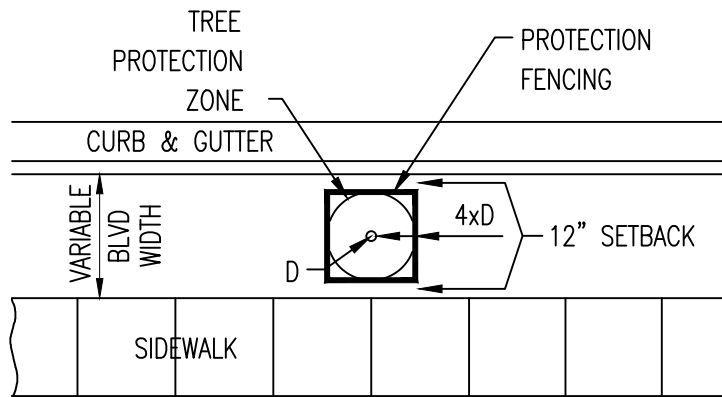

DEPARTMENT OF PUBLIC WORKS CITY OF ROCHESTER, MINNESOTA STRUCTURAL SOIL DETAIL TYPE 1			
 CITY ENGINEER			
SHT 1 OF 1 SHTS	DATE REVISED 1/26/24	PLATE NO. 5-02	REV. C

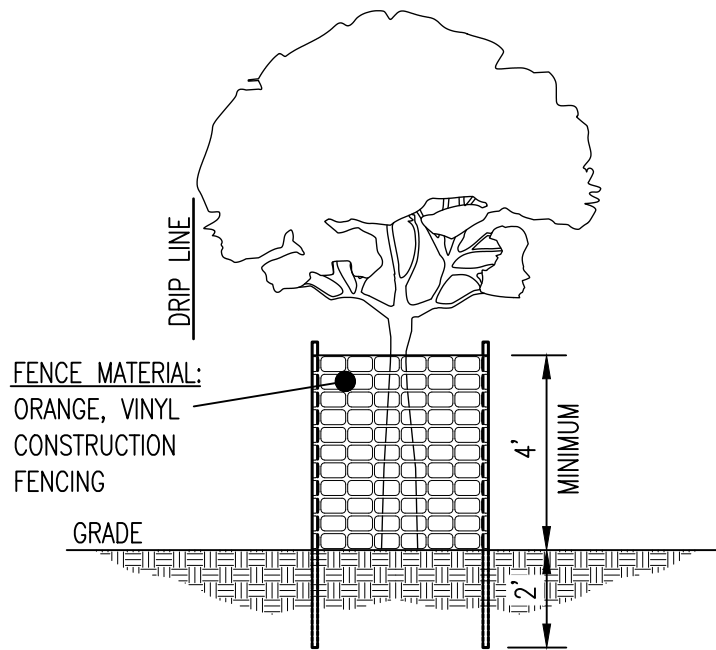
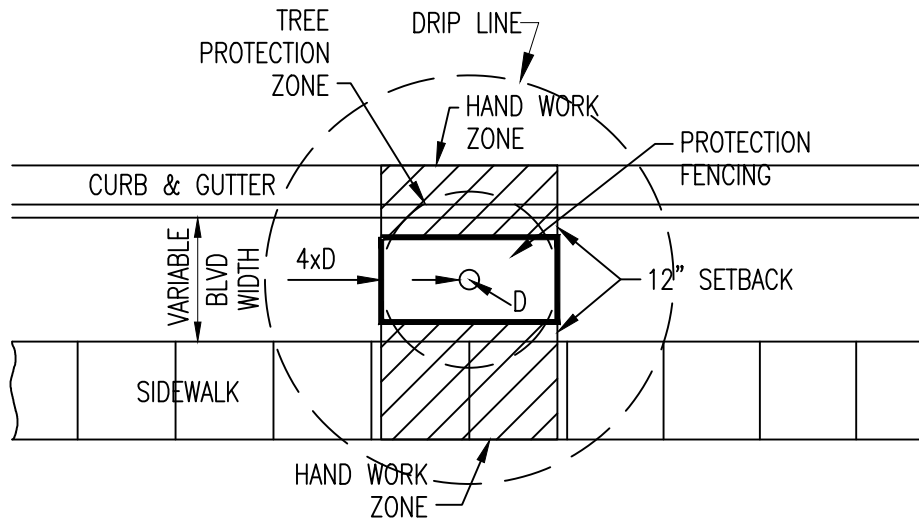

DEPARTMENT OF PUBLIC WORKS CITY OF ROCHESTER, MINNESOTA TREE PROTECTION ZONE TYPE 1			
 CITY FORESTER		 PARKS & REC DIRECTOR	
SHT 1 OF 4 SHTS	DATE REVISED 3/23/18	PLATE NO. 5-03	REV. A



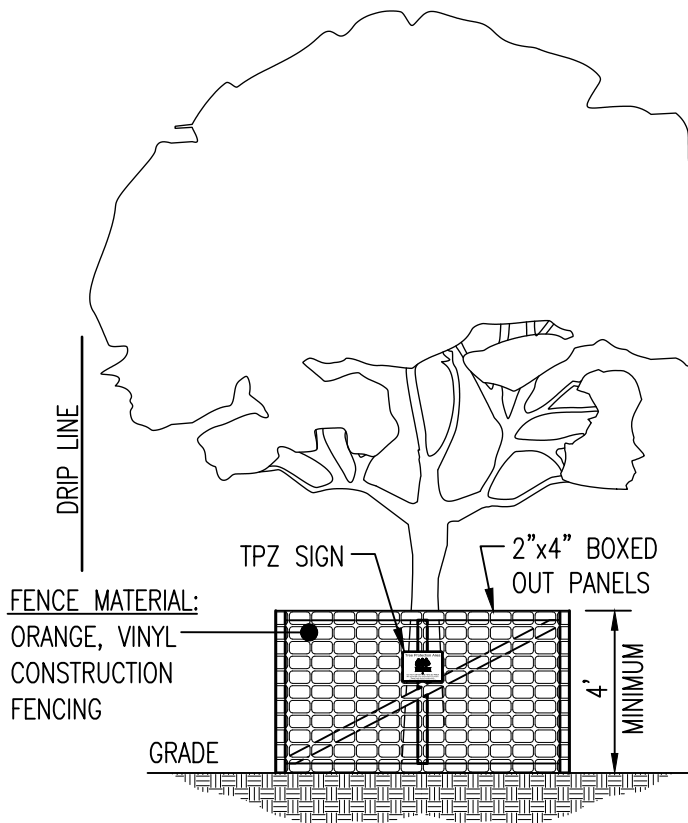
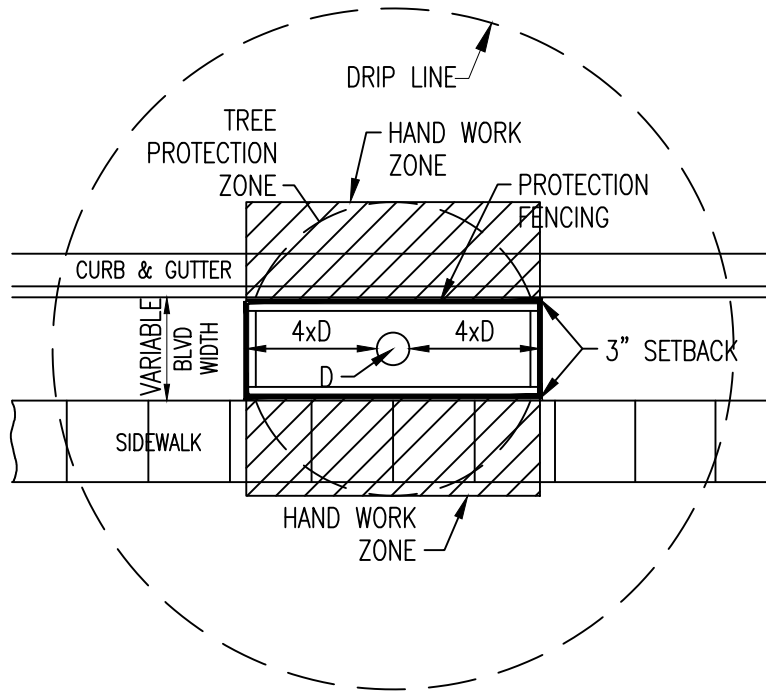

HAND WORK ZONE -
 ALL WORK IN THIS ZONE SHALL BE COMPLETED
 WITHOUT THE USE OF HEAVY EQUIPMENT, AND
 WITH HAND OPERATED TOOLS ONLY.

DEPARTMENT OF PUBLIC WORKS CITY OF ROCHESTER, MINNESOTA TREE PROTECTION ZONE TYPE 2			
 CITY FORESTER		 PARKS & REC DIRECTOR	
SHT 2 OF 4 SHTS	DATE REVISED 3/23/18	PLATE NO. 5-03	REV. A





CONTRACTOR IS TO AVOID EQUIPMENT IN THE DRIP LINE ZONE FOR LONG PERIODS AND MUST DIVERT EXHAUST.

HAND WORK ZONE - ALL WORK IN THIS ZONE SHALL BE COMPLETED WITHOUT THE USE OF HEAVY EQUIPMENT, AND WITH HAND OPERATED TOOLS ONLY.

DEPARTMENT OF PUBLIC WORKS CITY OF ROCHESTER, MINNESOTA TREE PROTECTION ZONE TYPE 3			
 CITY FORESTER		 PARKS & REC DIRECTOR	
SHT 3 OF 4 SHTS	DATE REVISED 3/23/18	PLATE NO. 5-03	REV. A

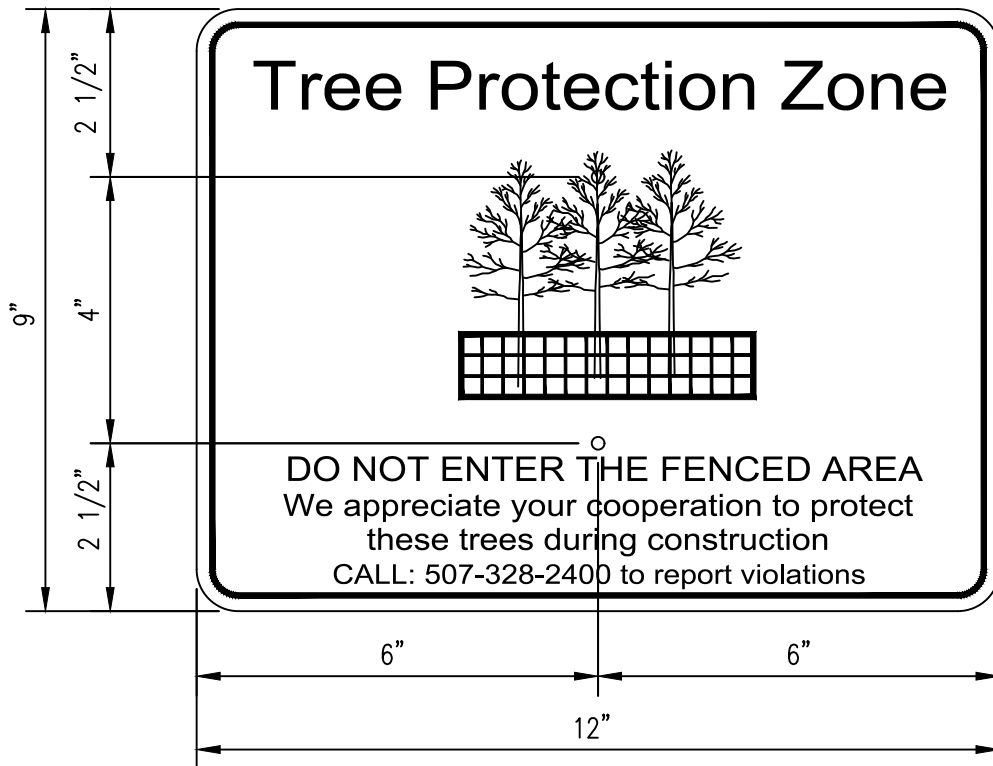
1. SIGN MATERIAL SHALL BE .063 5052 ALUMINUM HIGH INTENSITY SHEETING.
2. FABRICATE 12" x 9" SIGN WITH 0.75" RADIUS CORNERS.
3. SIGN SHALL BE WHITE WITH BLACK LETTERING.
4. ATTACH SIGN TO POST USING 1" LENGTH WOOD SCREWS.



DEPARTMENT OF PUBLIC WORKS CITY OF ROCHESTER, MINNESOTA TREE PROTECTION ZONE SIGN			
 CITY FORESTER		 PARKS & REC DIRECTOR	
SHT 4 OF 4 SHTS	DATE REVISED 3/23/18	PLATE NO. 5-03	REV. A